

Axes de recherche des enseignants de la spécialité Energétique

1 Optimisation des transferts dans les systèmes thermiques

- échangeurs, mini-canaux, mousses, métalliques et céramiques, écoulement

2 Valorisation énergétique des Agro Ressources

- biomasse, pyrolyse, gazéification, gaz de synthèse

3 Instrumentation et caractérisation thermo-physique multi-échelle

- propriétés thermiques et radiatives, matériaux poreux, fluides caloporteurs et nanofluides...

Systemes thermiques

1

Optimisation d'un évaporateur à mini-canaux par la maîtrise de la distribution en fluide frigorigène



Echangeur soumis à un apport de chaleur modulé par effet Joule

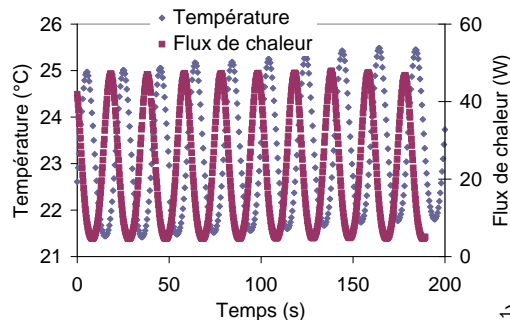

$$\alpha = f \left(\begin{array}{l} P, \omega, \theta, \text{dimensions,} \\ \text{propriétés du matériau} \end{array} \right)$$



Mesure de la distribution des coefficients d'échange thermique

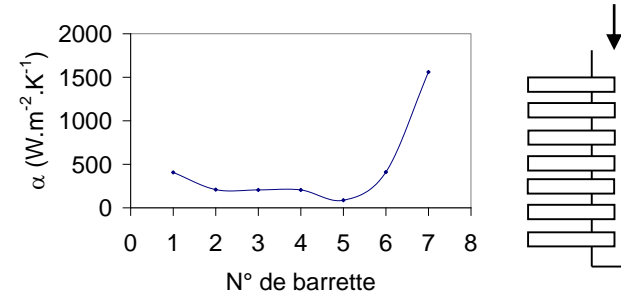

Thèse Patrick Leblay 2012
(A. Bontemps, L. Fournaison, JF. Henry)

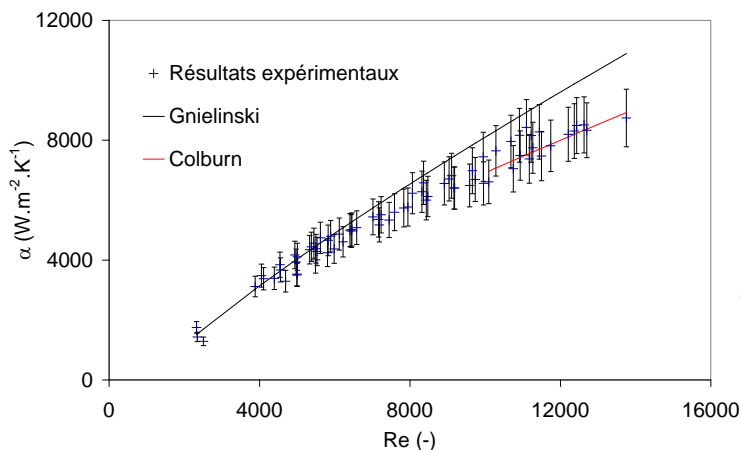

Résultats obtenus avec un tube rond dans le cas d'un fluide monophasique



Systemes thermiques

1

Amélioration de la performance énergétique des échangeurs par nanofluides caloporteurs

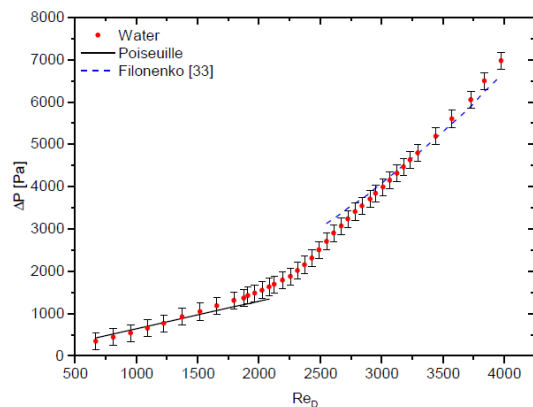
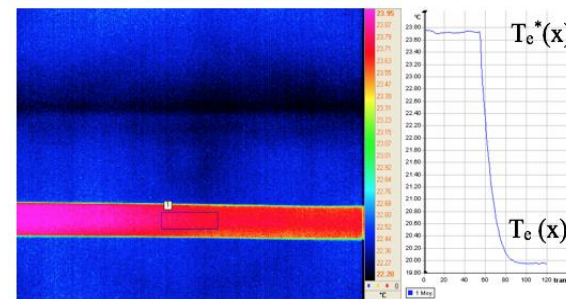
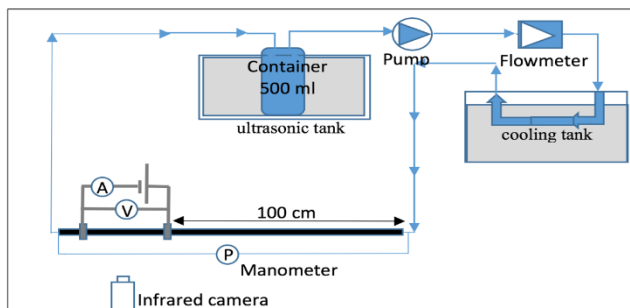

Pressure drop in the test section versus Reynolds number for water

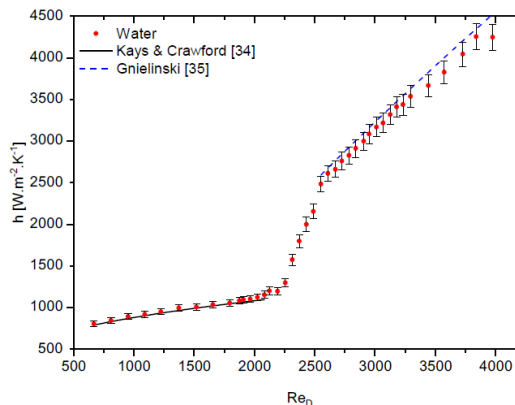

Convective heat transfer coefficient versus Reynolds number for water

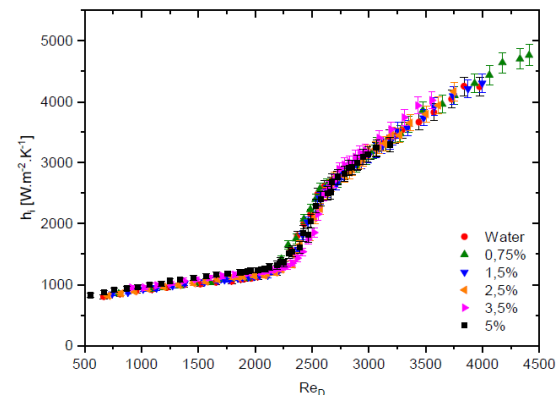

Convective heat transfer coefficient versus Reynolds number for water and different concentration of Al₂O₃ water nanofluid

Thèse Alexandre Briclot 2019-2022

(S. Fohanno, C. Popa, JF. Henry)

Contact : S. Fohanno@univ-reims.fr

Université de Reims Champagne-Ardenne





Systemes thermiques

1

Récupération de l'énergie dans les eaux grises pour préchauffer l'arrivée d'eau froide

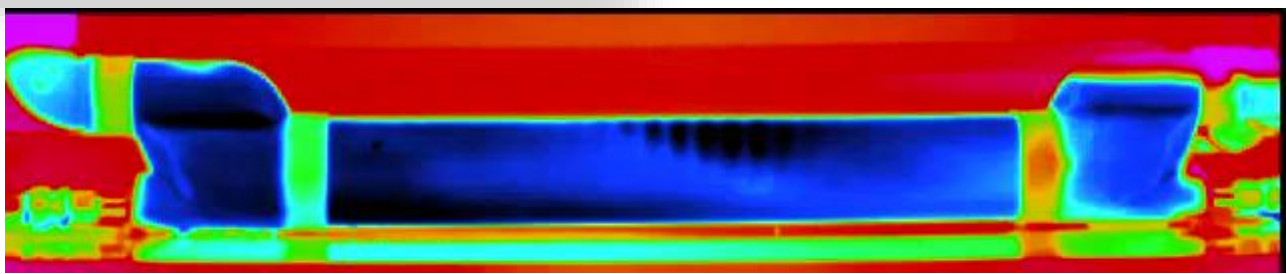
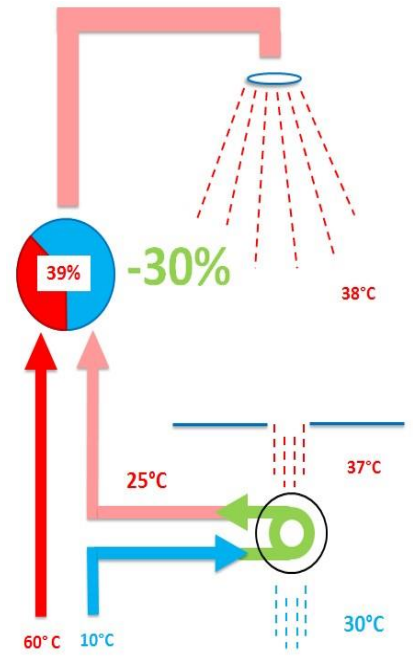
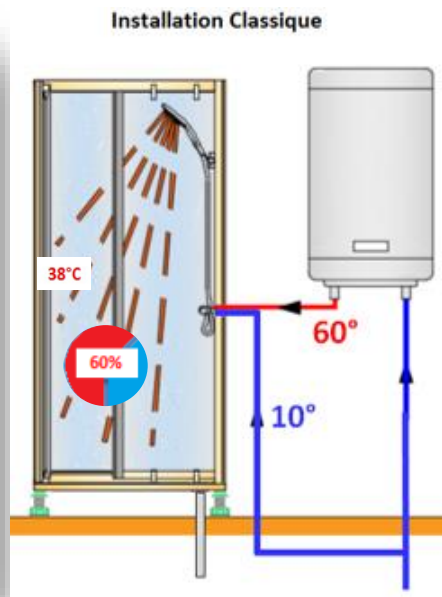
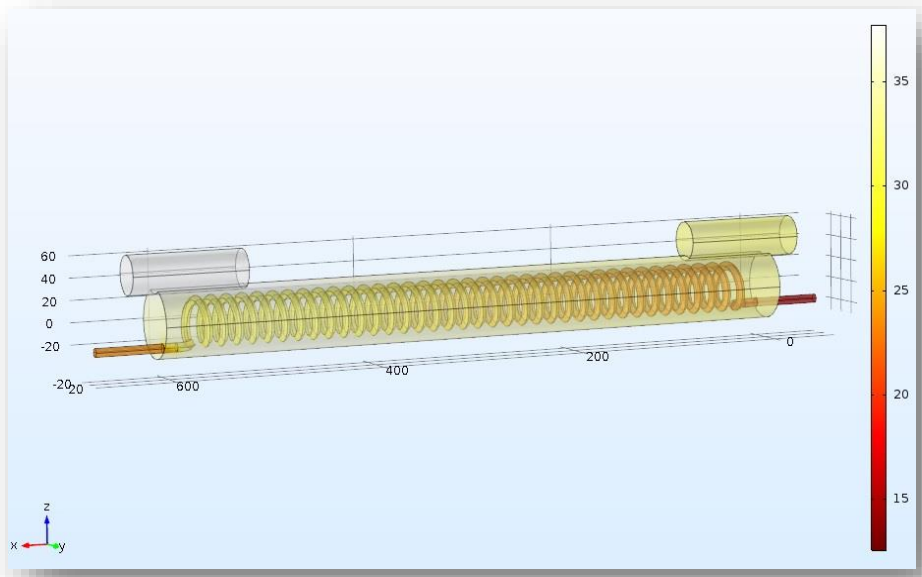

Systèmes thermiques

1

Détermination des propriétés de transport des mousses en céramique

Etude des matériaux poreux

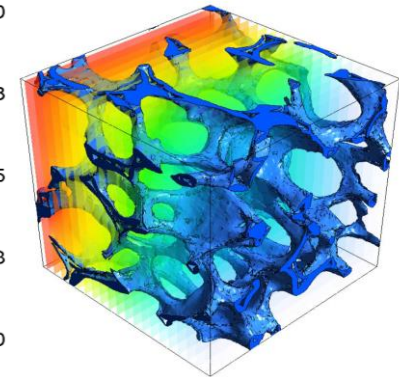
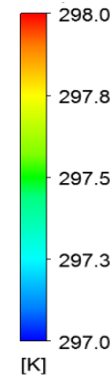
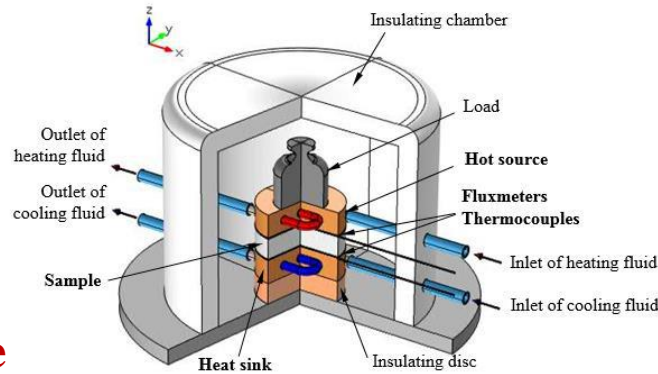

Conductivité thermique

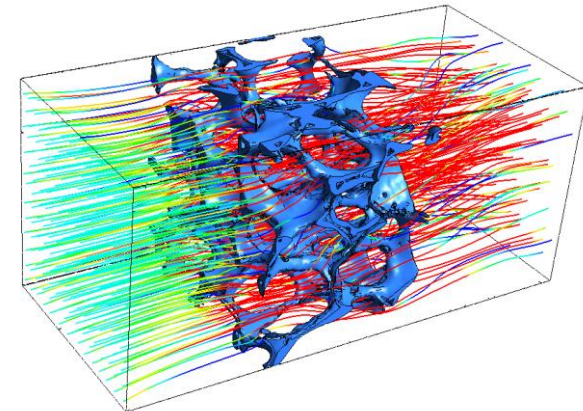
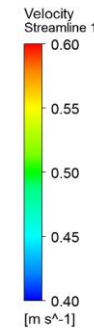
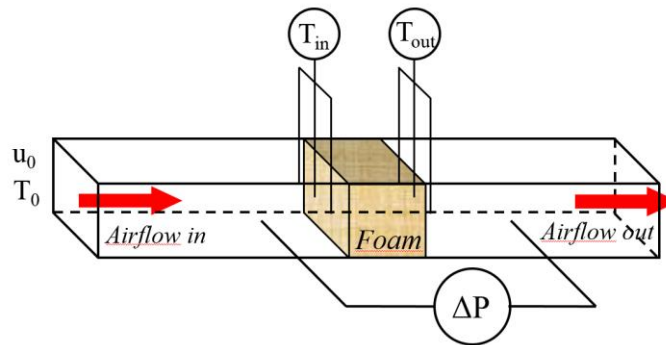

Perméabilité et coefficient de Forchheimer

Thèse Pierre Léa 2017-2020

(J. Randrianalisoa, H. Pron, JF. Henry)



Systemes thermiques

1

Détermination des propriétés de transport des mousses en céramique

Recherche fondamentale

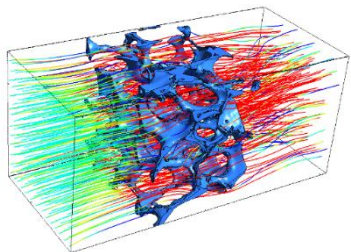

Détermination des propriétés de transports des mousses

Simulation numérique à l'échelle du pore

Caractérisation expérimentale

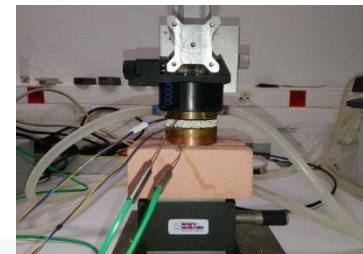

Validation

Application directe



Simulation poêle à bois et filtre à particules

Echangeur solaire Haute température



Validation

Partenaire EPFL



Modélisation aéraluque de la combustion dans un poêle à granulés

invicta | group

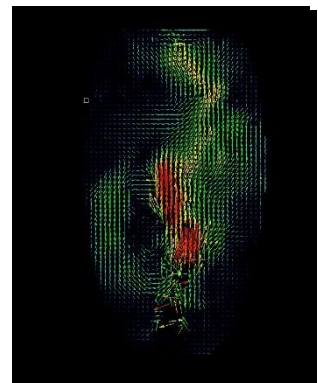
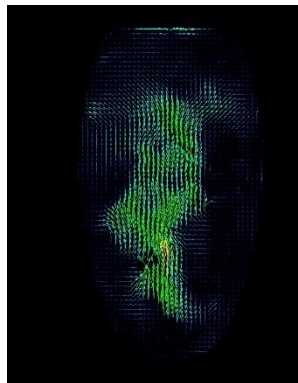
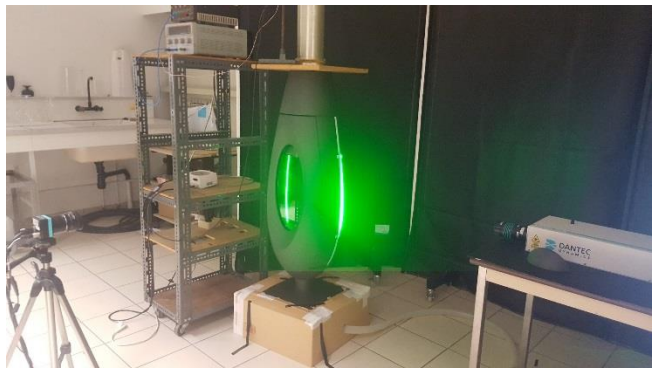

Visualisation de l'écoulement par PIV (Particle image velocimetry) Ecoulement à 0,17 m/s Ecoulement à 0,27 m/s

Grand Est
ALSACE CHAMPAGNE-ARDENNE LORRAINE

l'Europe
s'engage
en France

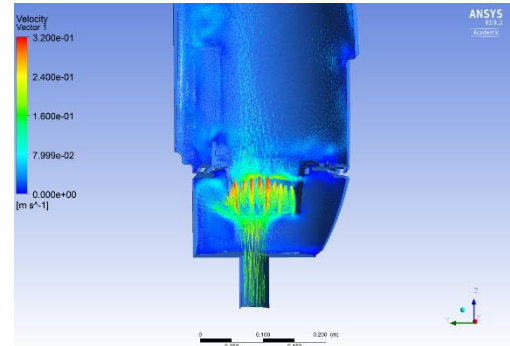
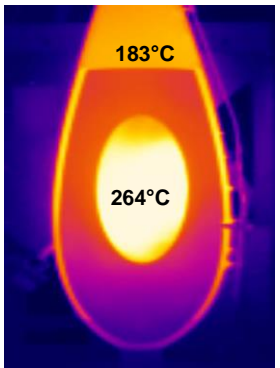

Opticomb: programme de recherche collaborative
(J.F. Henry, J. Randrianalisoa)

Contacts : jf.henry@univ-reims.fr
jaona.randrianalisoa@univ-reims.fr

Université de Reims Champagne-Ardenne



2 Valorisation énergétique des matériaux biosourcés

Modélisation de la combustion dans un poêle à granulés

invicta | group |

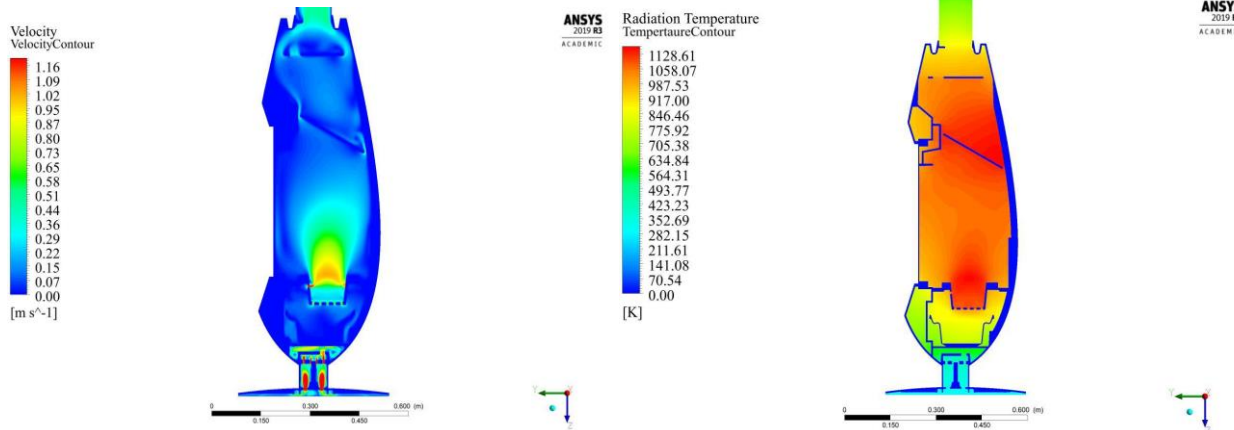

Table 4
Combustion reactions and kinetics.

Homogeneous reactions		Kinetics
(R.4)	$C_6H_6 + \frac{9}{2}O_2 \rightarrow 6CO + 3H_2O$	$R_{1,kin} = 1.3496 \times 10^9 \exp\left(-\frac{1.256 \times 10^8}{RT}\right) [C_6H_6]^{-0.1} [O_2]^{1.85}$
(R.5)	$CH_4 + \frac{3}{2}O_2 \rightarrow CO + 2H_2O$	$R_{2,kin} = 5.012 \times 10^{11} \exp\left(-\frac{2 \times 10^8}{RT}\right) [CH_4]^{-0.7} [O_2]^{0.8}$
(R.6)	$H_2 + \frac{1}{2}O_2 \rightarrow H_2O$	$R_{3,kin} = 9.87 \times 10^8 \exp\left(-\frac{3.1 \times 10^7}{RT}\right) [H_2][O_2]$
(R.7)	$CO + \frac{1}{2}O_2 \rightarrow CO_2$	$R_{4,kin} = 2.239 \times 10^{12} \exp\left(-\frac{1.702 \times 10^8}{RT}\right) [CO][O_2]^{0.25} [H_2O]^{0.5}$
(R.8)	$H_2O + CO \rightarrow CO_2 + H_2$	$R_{5,kin} = 2.780 \exp\left(-\frac{1.255 \times 10^7}{RT}\right) [H_2O][CO]$
(R.9)	$CO_2 + H_2 \rightarrow H_2O + CO$	$R_{3,kin} = 93690 \exp\left(-\frac{4.659 \times 10^7}{RT}\right) [CO_2][H_2]$

Opticomb: programme de recherche collaborative
(JF. Henry, J. Randrianalisoa)

Université de Reims Champagne-Ardenne



Systèmes thermiques

1

Refroidissement des composants du Synchrotron SOLEIL
par micro-canaux et picots



Accélérateur de particules \rightarrow (e^-)
Rayonnement Synchrotron
**SOLEIL : Source Optimisée de Lumière
d'Energie Intermédiaire du LURE***

LURE: *Laboratoire d'Utilisation du Rayonnement
Électromagnétique.*

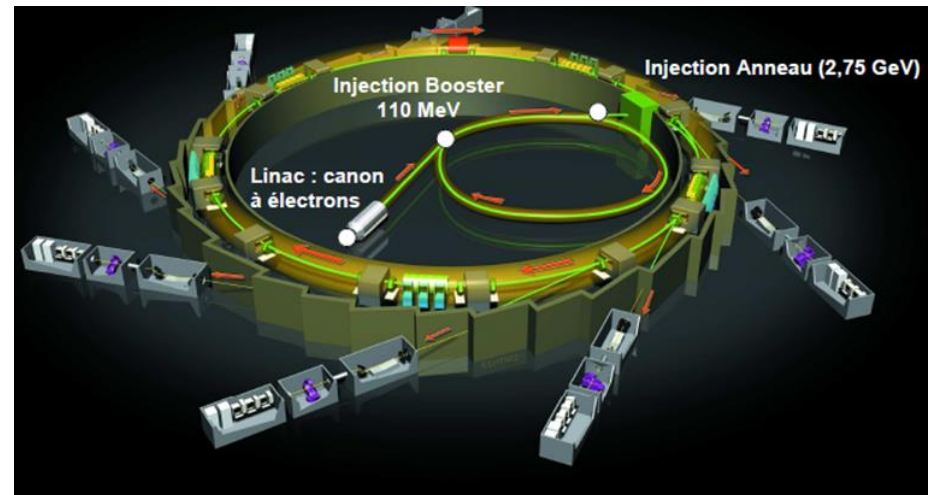
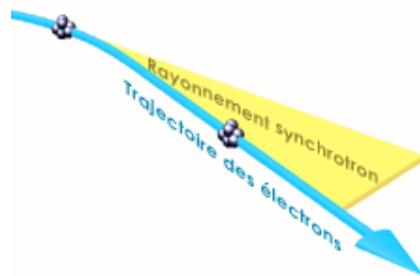

Un anneau de 354 m de circonférence (113 m de diamètre)



Systemes thermiques

1

Refroidissement des composants du Synchrotron SOLEIL par micro-canaux et picots

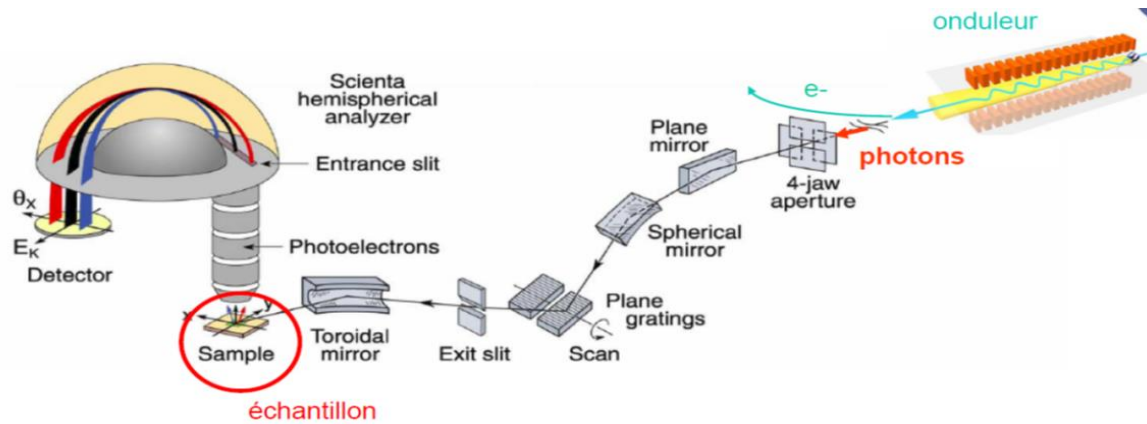

Systemes thermiques

1

Refroidissement des composants du Synchrotron SOLEIL
par micro-canaux et picots

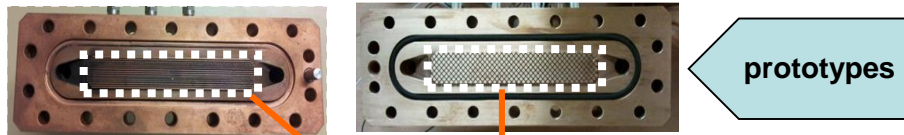

prototypes

simulation
numérique

$L \times W = 100 \times 16 \text{ mm}^2$

Étude
d'Optimisation

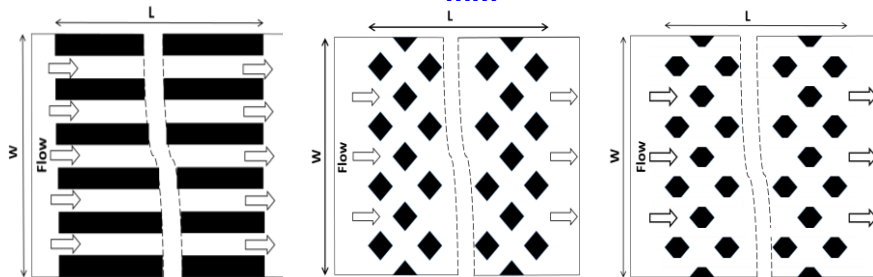

(a) canaux rectangulaires (b) picots (c) picots améliorés

Champ de vitesses (m/s)
($e = 1.6 \text{ mm}$ et $\dot{m} = 3 \text{ kg/mn}$)

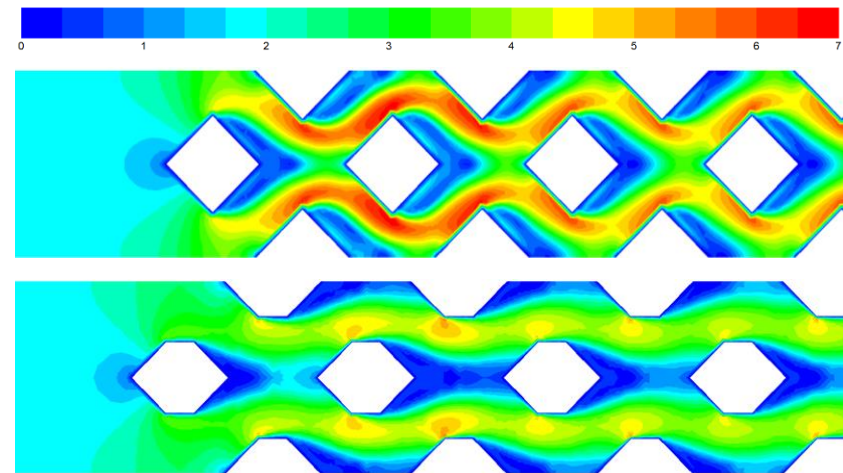

2 Valorisation énergétique des matériaux biosourcés

Synthèse de biogaz à partir de matériaux cellulosiques

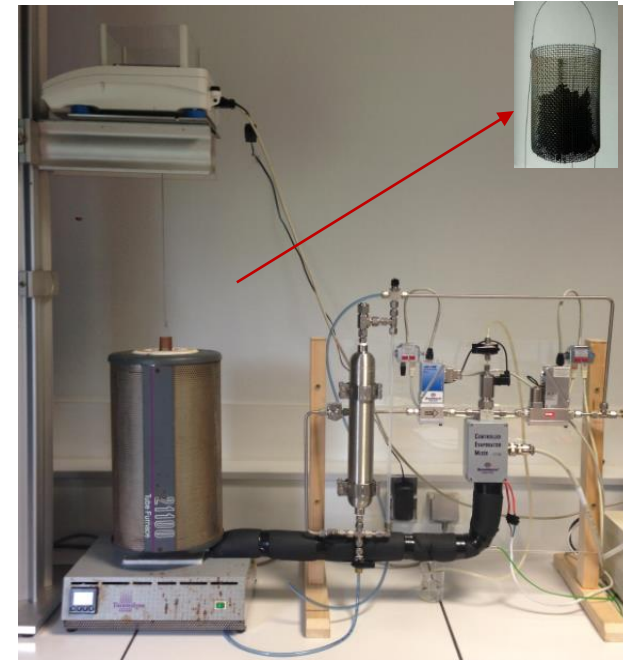
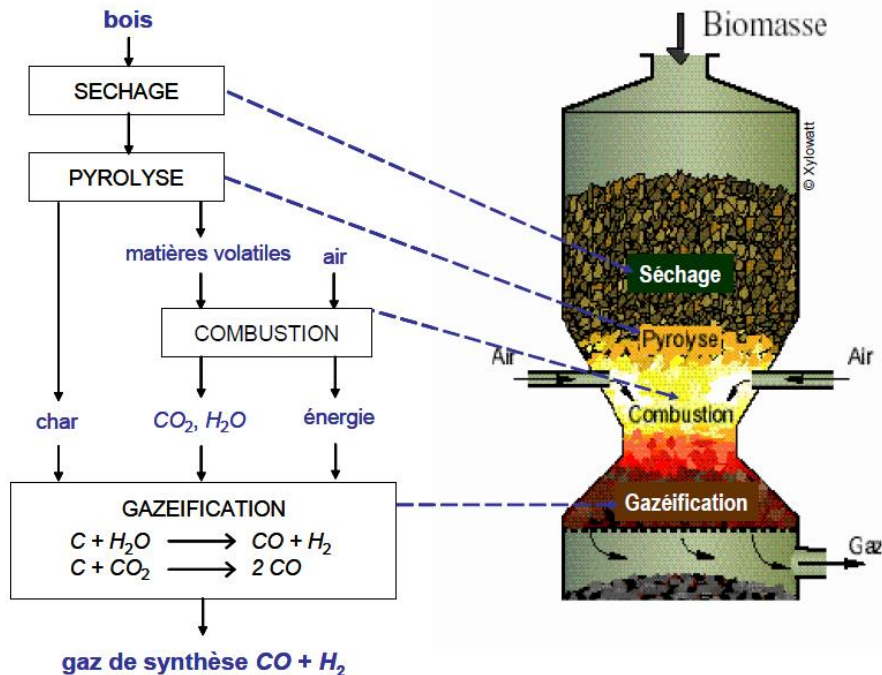

*Thèse Clarisse Lorreyte 2018
(H. Pron, J. Randrianalisoa)*



2

Valorisation énergétique des matériaux biosourcés

Synthèse de biogaz à partir de matériaux cellulosiques

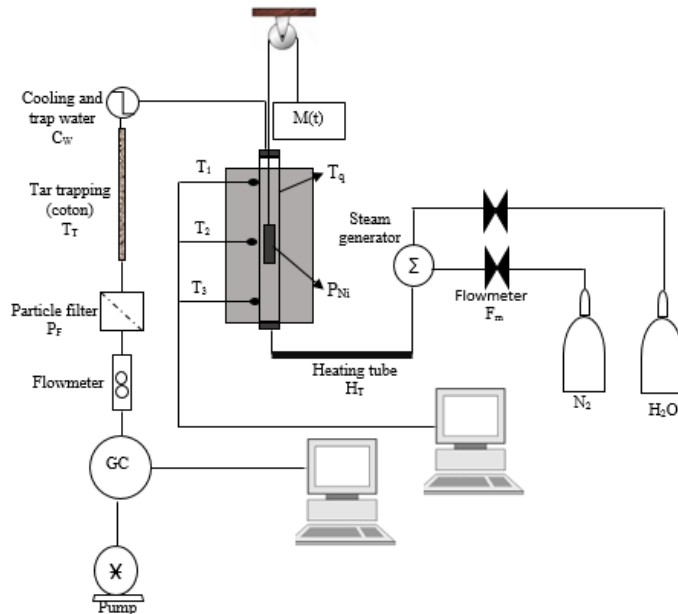

- **Simulation numérique** des processus de pyrolyse et de gazéification (Comsol)
- **Détermination de propriétés de la biomasse** : porosité, coefficient d'échange, perméabilité, tortuosité

*Thèse Clarisse Lorreyte 2018
(H. Pron, J. Randrianalisoa)*



2

Modélisation numérique

Cartographie des vitesses du fluide

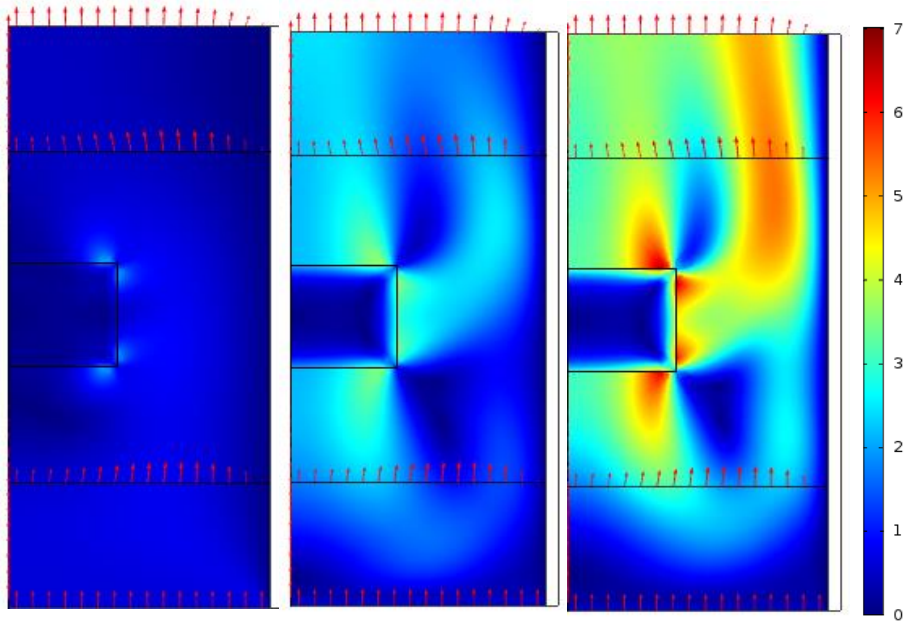

t = 10 s *t = 1 min* *t = 15 min*

Pyrolyse à 500°C

Transfert de chaleur dans la phase solide

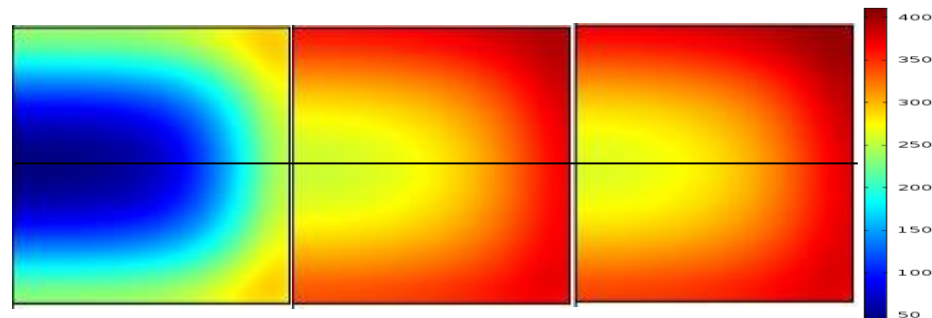

t = 10 s *t = 1 min* *t = 15 min*

Pyrolyse à 500°C

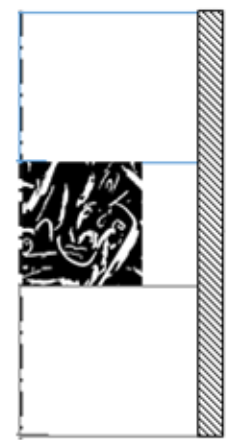

Université de Reims Champagne-Ardenne



2 Valorisation énergétique des matériaux biosourcés

Thermique du bâtiment



- **Matériaux biosourcés** à base de chanvre, typha, liège... avec un liant minéral ou polymère
- **Caractérisation thermophysique** : mesure des propriétés thermiques, hydriques, mécaniques, acoustiques et porosité

• Evaluation des performances énergétiques Modélisation numérique

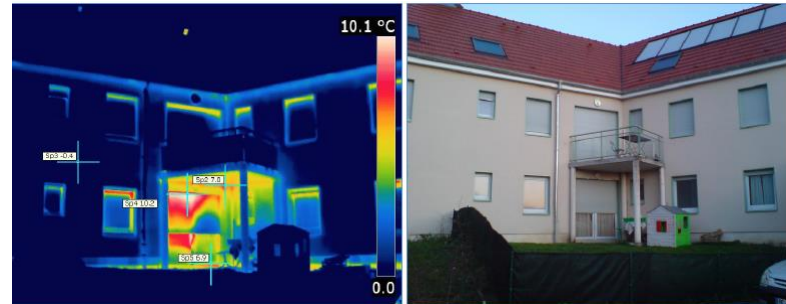
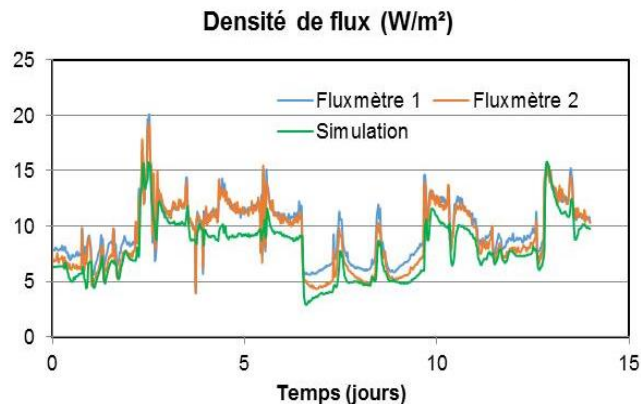

- **Evaluation des performances énergétiques**
Suivi expérimental *in situ*



3

Instrumentation et caractérisation thermophysique

Caractérisation de liquides (nanofluides, matériaux à changement de phase MCP,...)

Mesure de la conductivité thermique
Méthode 3ω : fil chaud modulé en température

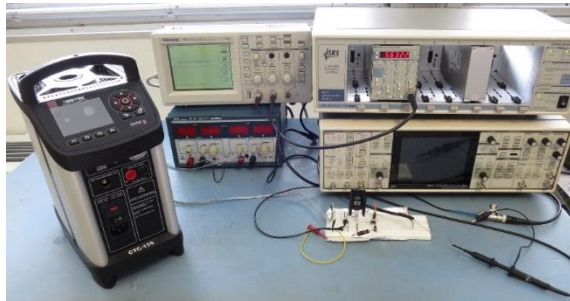
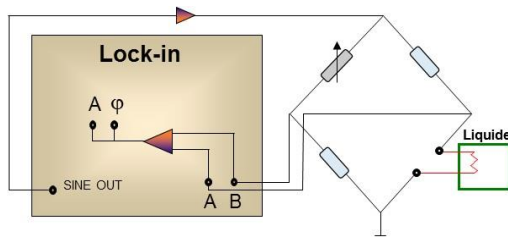

*Thèse Salim Arous 2019-2021
(M.Chirtoc, N.Horny, JF.Henry)*

Mesure de la chaleur spécifique
Calorimétrie (SETARAM C80)

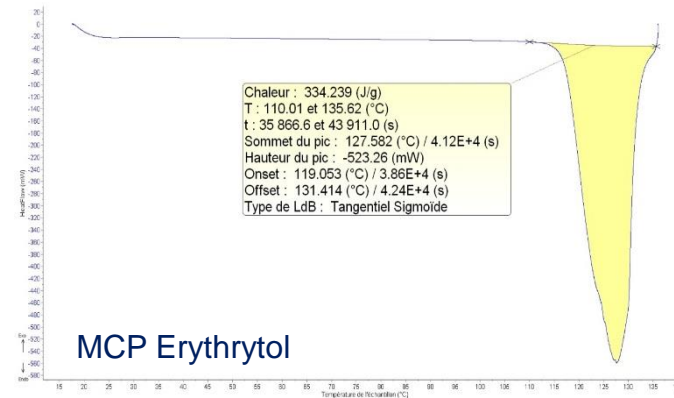

3

Instrumentation et caractérisation thermophysique

Microscopie thermique à sonde locale

Etude amont : Interprétation de la mesure par microscopie thermique

Application : Nano analyse thermique de biopolymères

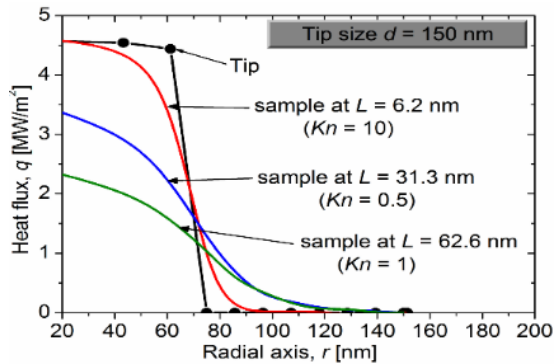
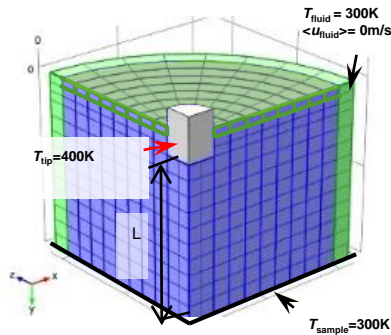

Application à l'étude de la mobilité des biopolymères constitutifs des parois de cellules végétales (Collaboration INRA)

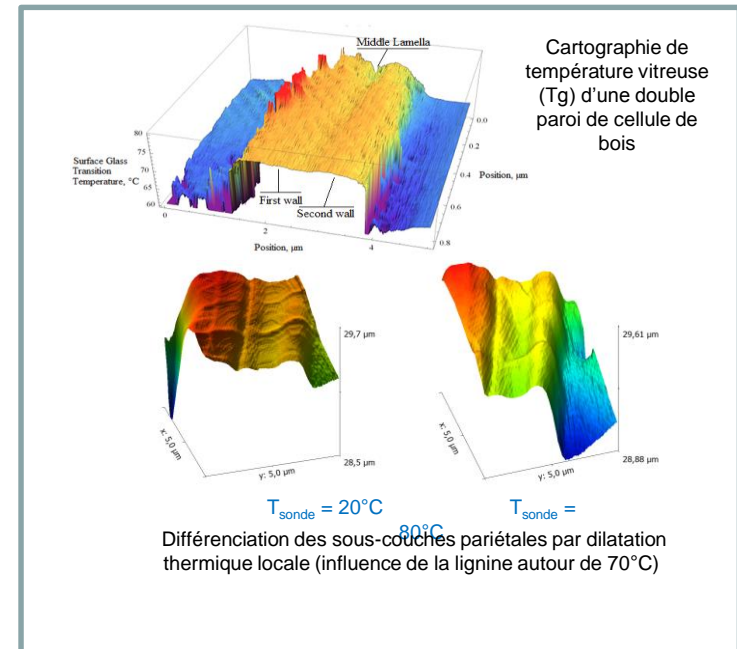



3

Instrumentation et caractérisation thermophysique

Thermographie infrarouge stimulée

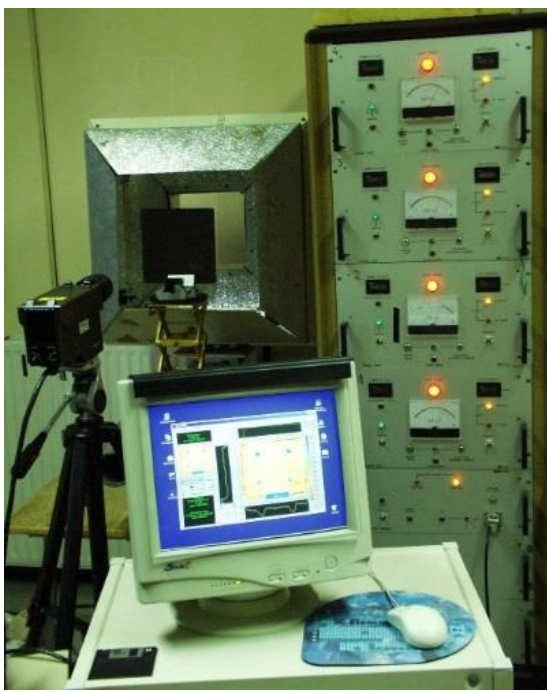
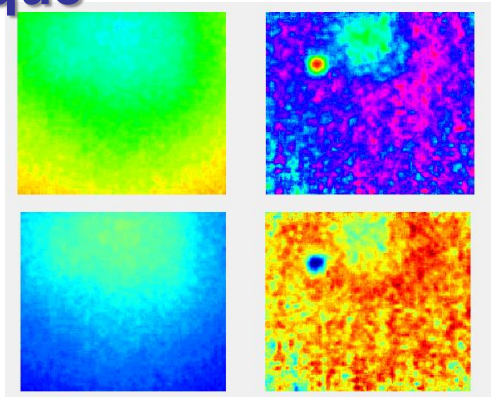

Détection et caractérisation géométrique de défauts structurels





Collaborations internationales :

Australie : W.LIPINSKI de l'Australian National University

Brésil : R. Cotta, Université Fédérale de Rio de Janeiro

Canada : C.T. Nguyen, Université de Moncton, N. Galanis - Université de Sherbrooke

Italie : C. Ingrao de l'Université de Foggia, F. Scrucca de l'Université de Perugia

Pologne : J. Bodzenta, J. Jusczyk, Université de Gliwice

Roumanie : E.C. Mladin et I. Colda de l'Université Polytechnique de Bucarest, C. Chereches et I. Gherasim de l'Université Technique de Iasi

Suisse : S. Haussener de l'Ecole Polytechnique Fédérale de Lausanne

Tunisie : Laboratoire LESTE, Université de Monastir, R. Ben Maad de l'Université de Tunis El Manar

Turquie : S. Kakac de l'University of Economics and Technology, Ankara, Université Dokuz Eylül, Izmir

USA (Utah) : H. Ban, Université de Logan



Matériels...

Caméras de thermographie infrarouge
Caméra vidéo rapide
Corps noirs
Spectromètres
Système PIV
Calorimètre
Conductivimètre
Scanner 3D
SThM, AFM
Etuve programmable
Enceintes climatiques (dont bi-climatique)
Porosimètre à mercure
Machine de fatigue 2 tonnes
Lasers
Dispositifs de caractérisation photothermique
(flash et sinus)
Banc de mesure de coefficients d'échanges en
canalisation
Logiciels : Ansys Fluent 16.0, Comsol, Solidworks,
Artec Studio 10 ...

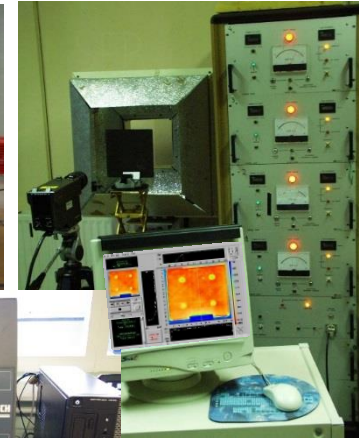
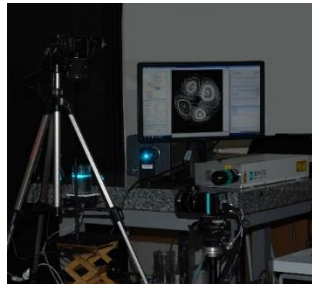

+ accès aux matériels des plateformes

